

# Anpassungen XML-Standard hospitalMCD 4.52 – generalMCD 5.0

Finale Version

[fachorgan@forum-datenaustausch.ch](mailto:fachorgan@forum-datenaustausch.ch)

09.12.2024

# generalMCD (Request) 5.0

# request / processing

## XML 4.52

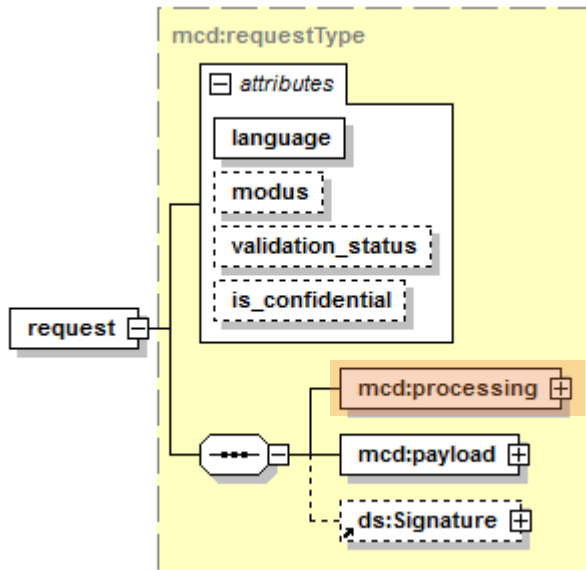

## XML 5.0

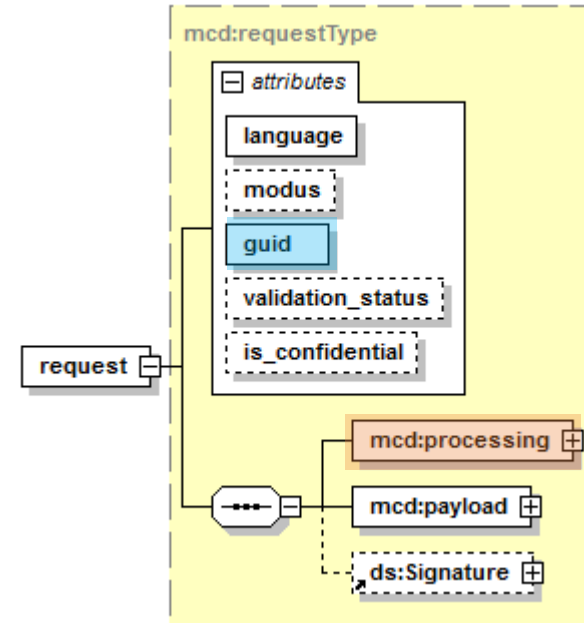

### Problematik XML 4.5

Anpassungen processing

Zeitliche Terminierung 31.12.2030

### Anpassungen XML 5.0

Analoge Anpassung processing → generalInvoice 5.0 (via =0)

Aufhebung der zeitlichen Terminierung

Anpassung: Analog generalInvoice 5.0 → mcd mit guid

# request / payload

## XML 4.52

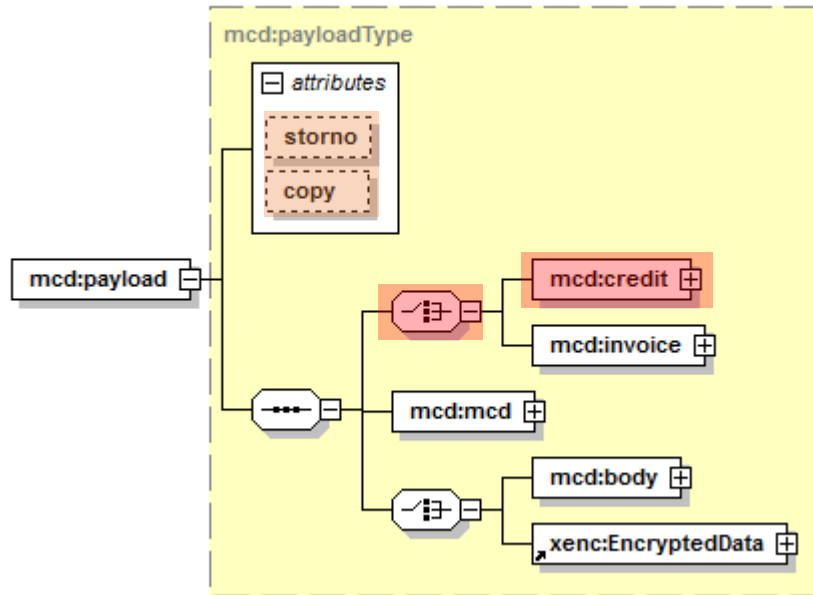

## XML 5.0

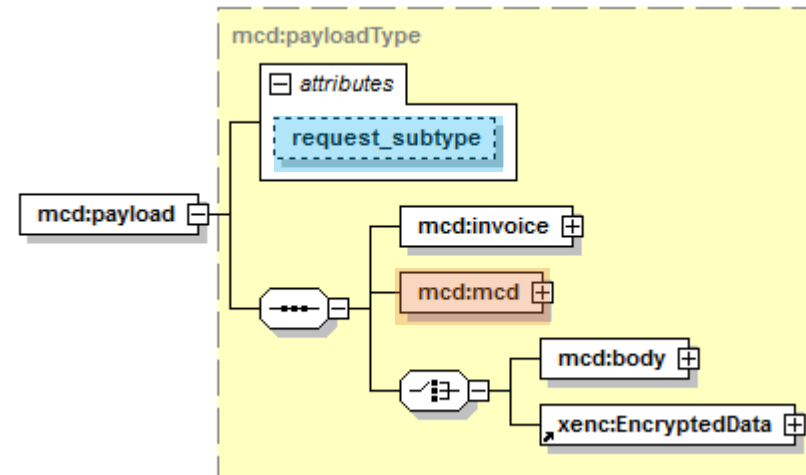

### Problematik XML 4.52

Löschen der credit-Struktur → Keine Verwendung

### Anpassungen XML 5.0

Ersatzlos gestrichen

Anpassung: Analog generalInvoice 5.0 → mcd mit guid

Anpassung: Analog generalInvoice 5.0 → Einführung subtype

# request / body / groupings

XML 4.52

XML 5.0

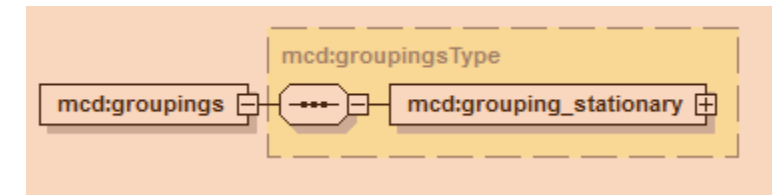
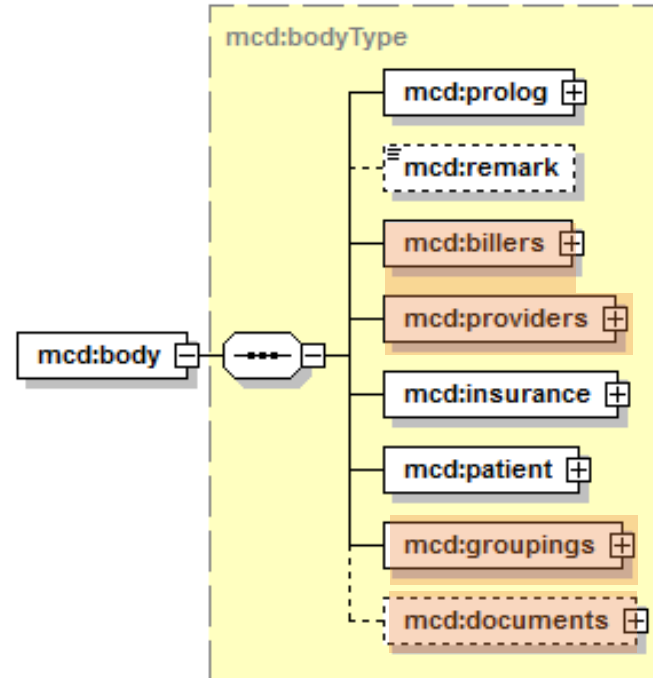
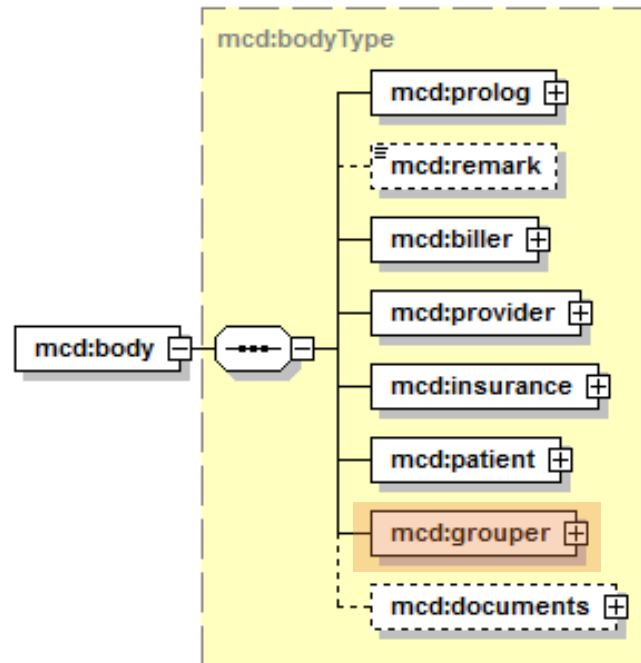

## Problematik XML 4.52

Nur stationäre Gruppierung möglich

## Anpassungen XML 5.0

Neu: Typisierte Gruppierung stationär (ambulant vorbereitet)

Anpassung billers & provider analog XML generalInvoice 5.0

Anpassung documents-Types analog XML generalInvoice 5.0

# request / body / grouping\_stationary

XML 4.52

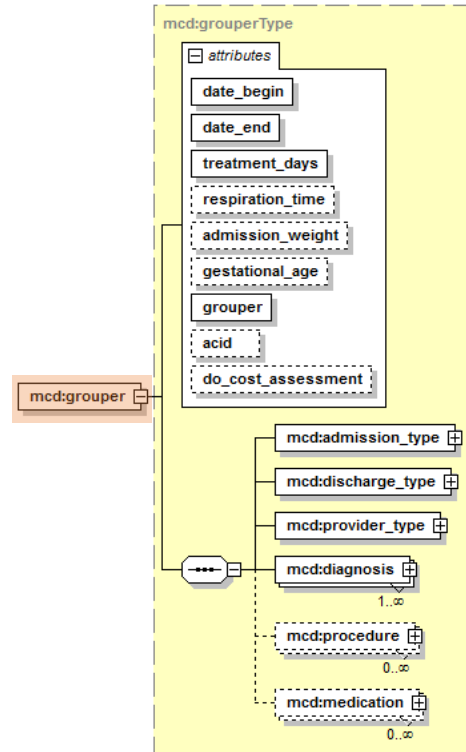

XML 5.0

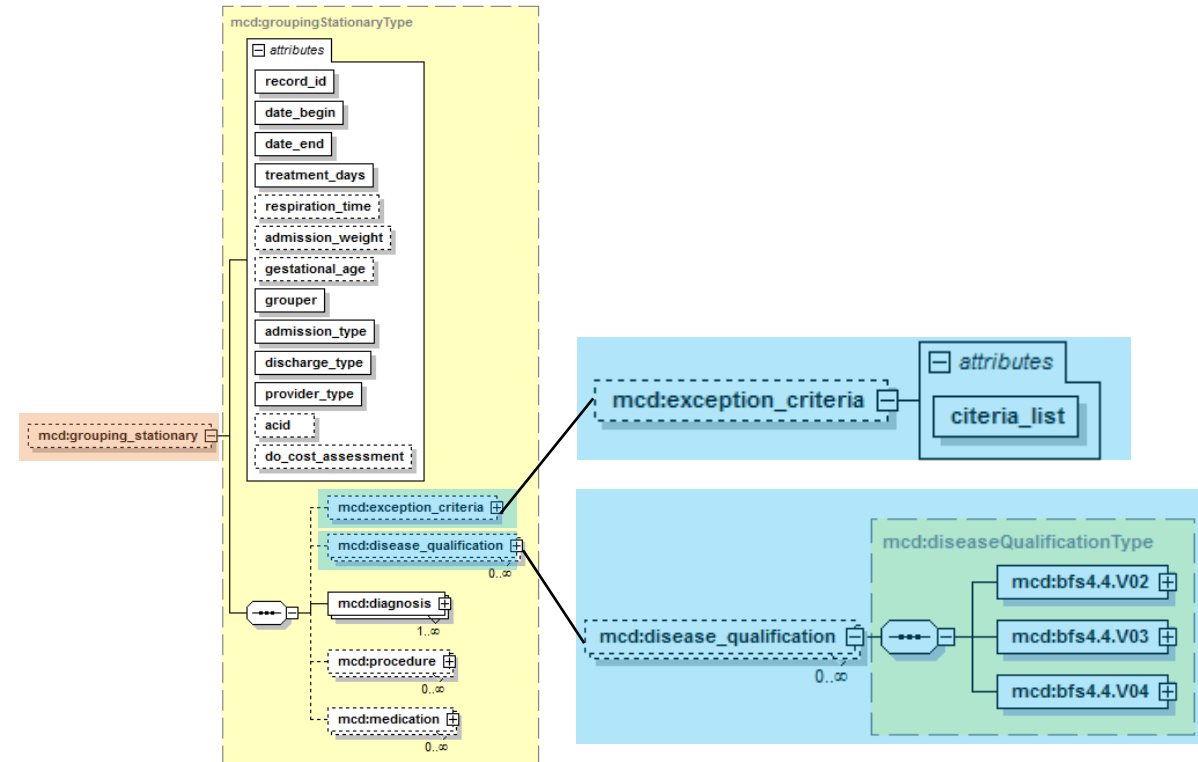

## Problematik XML 4.52

## Anpassungen XML 5.0

Neu: Kriterium ambulant vor stationär → KLV Anhang 1a

Neu: BfS hospital statistics: Severity Score, Score Catalogue & NEMS

# generalMCD (Response) 5.0

# response / processing

## XML 4.52

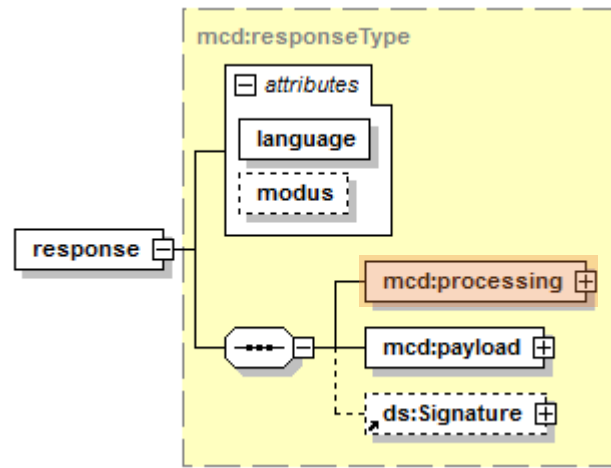

## XML 5.0

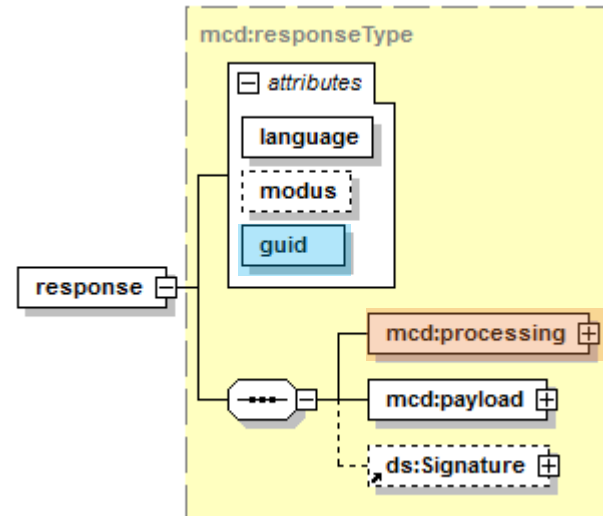

### Problematik XML 4.5

Anpassungen processing

Zeitliche Terminierung 31.12.2030

### Anpassungen XML 5.0

Analoge Anpassung processing → generalInvoice 5.0 (via = 0)

Aufhebung der zeitlichen Terminierung

Anpassung: Analog generalInvoice 5.0 → mcd mit guid



# response / payload

## XML 4.52

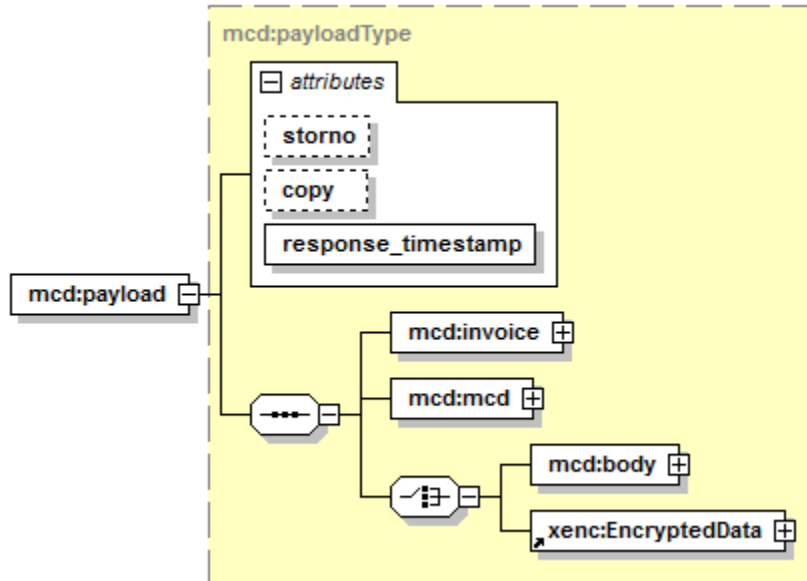

## XML 5.0

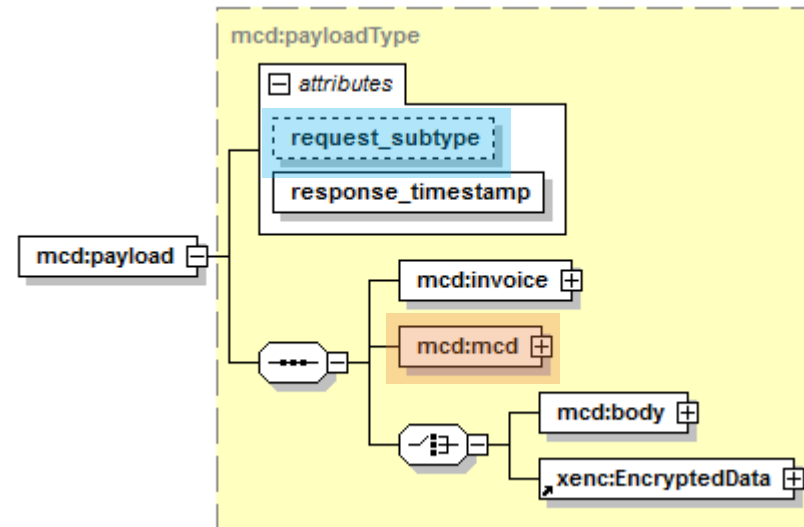

### Problematik XML 4.52

### Anpassungen XML 5.0

Anpassung: Analog generalInvoice 5.0 → mcd mit guid

Anpassung: Analog generalInvoice 5.0 → Einführung subtype

# response / body

## XML 4.52

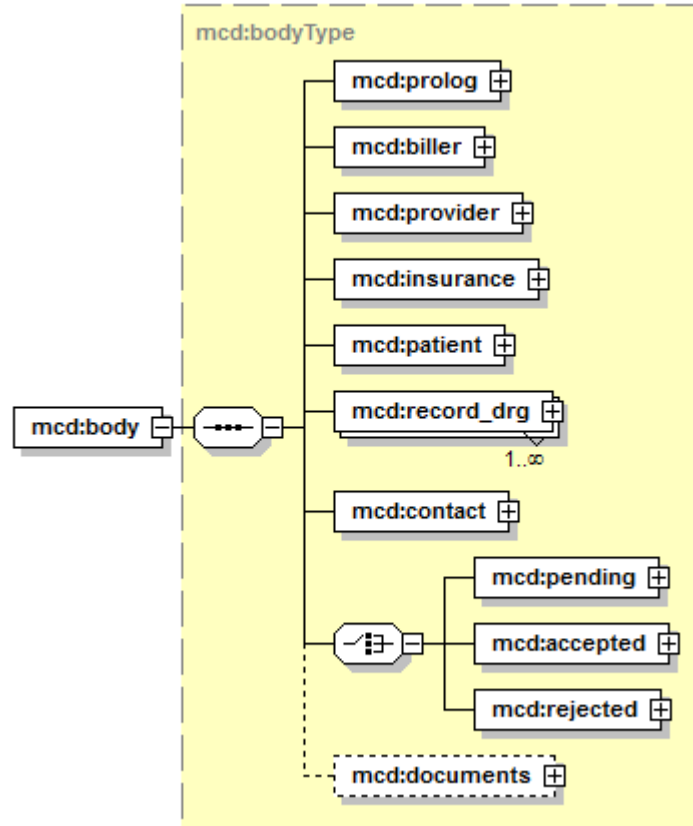

## XML 5.0

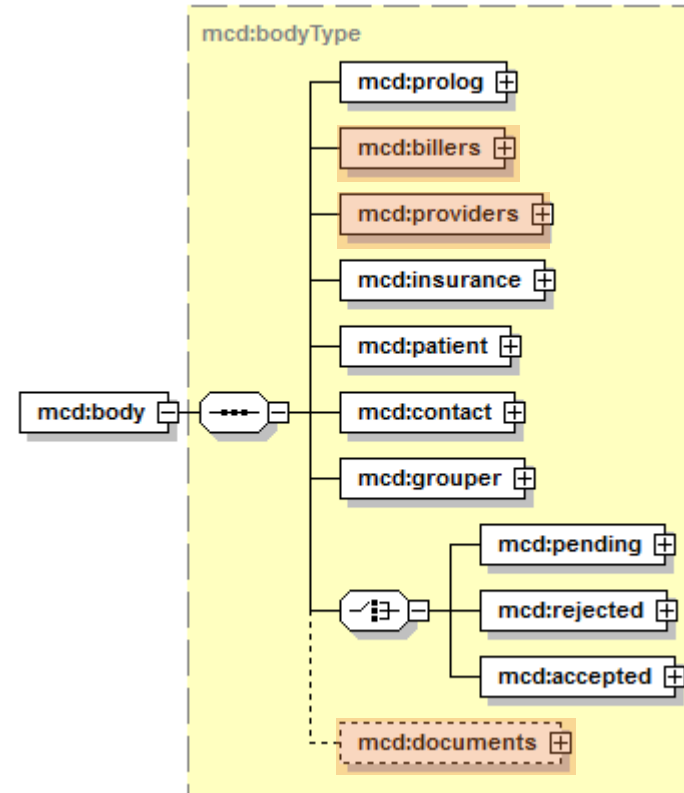

### Problematik XML 4.52

### Anpassungen XML 5.0

Anpassung billers & provider analog XML generalInvoice 5.0

Anpassung documents-Types analog XML generalInvoice 5.0



[fachorgan@forum-datenaustausch.ch](mailto:fachorgan@forum-datenaustausch.ch)