

Adaptations

XML-Standard hospitalMCD 4.52 – generalMCD 5.0

Version finale

fachorgan@forum-datenaustausch.ch

09.12.2024

generalMCD (Request) 5.0

request / processing

XML 4.52

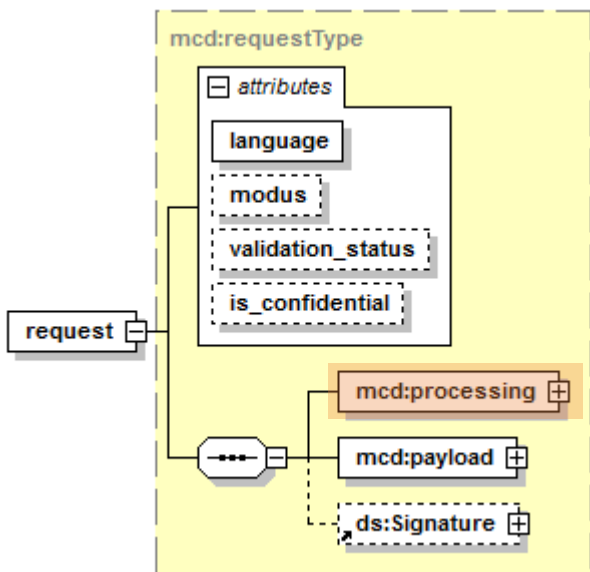

XML 5.0

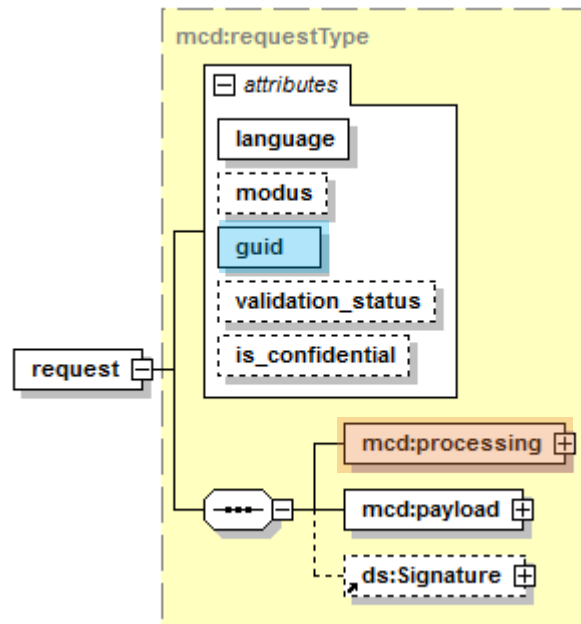

Problématique XML 4.5

Adaptations processing

Calendrier 31.12.2030

Adaptations XML 5.0

Adaptation analogique processing → generalInvoice 5.0 (via =0)

Suppression de l'ordonnancement temporel

Adaptation : Analog generalInvoice 5.0 → mcd avec guid

request / payload

XML 4.52

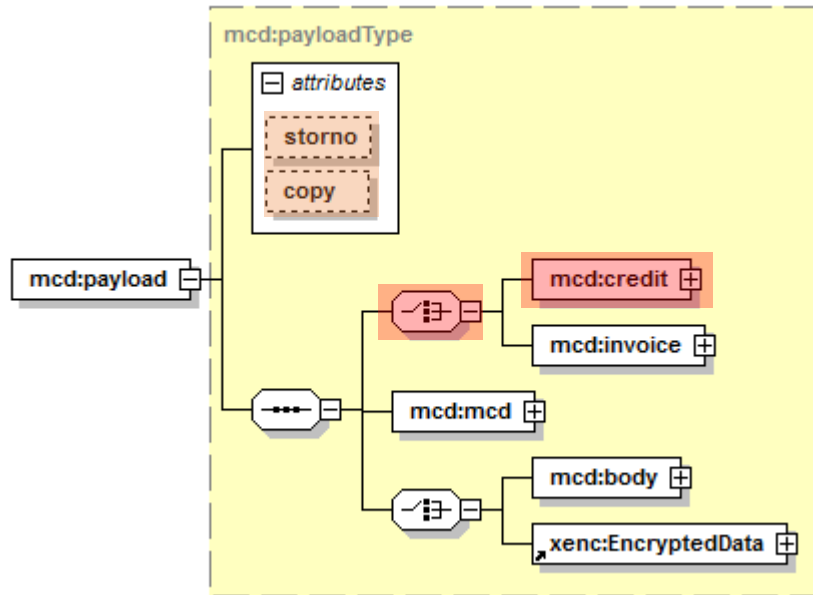

XML 5.0

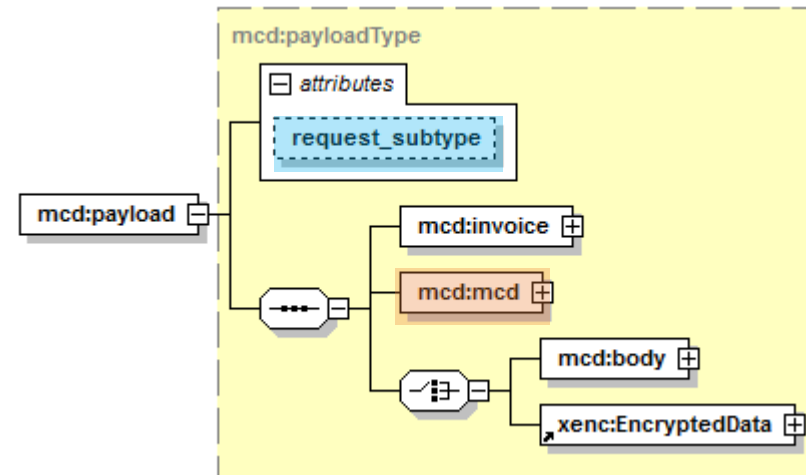

Problématique XML 4.52

Effacer la structure de crédit → Pas d'utilisation

Adaptations XML 5.0

Supprimé sans remplacement

Adaptation : Analog generalInvoice 5.0 → mcd avec guid

Adaptation : Analogue à generalInvoice 5.0 → Introduction de subtype

request / body / groupings

XML 4.52

XML 5.0

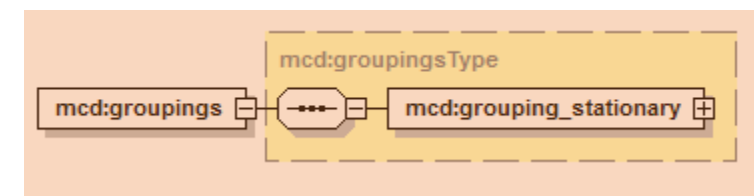
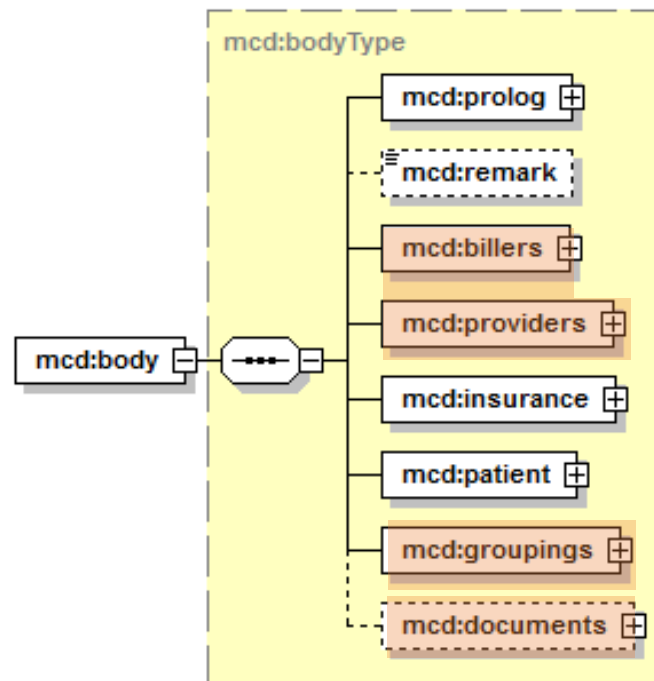
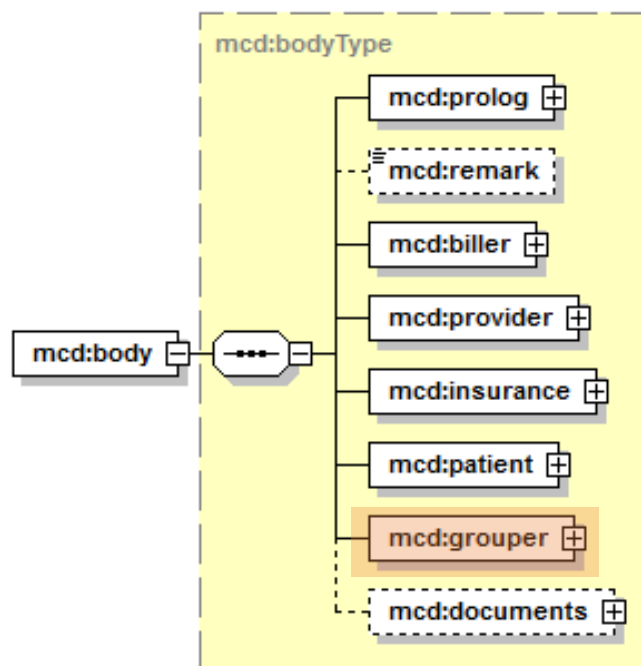

Problématique XML 4.52

Seul le regroupement stationnaire est possible

Adaptations XML 5.0

Nouveau : Regroupement typologique ambulatoire / stationnaire

Adaptation billers & provider analog XML generalInvoice 5.0

Adaptation documents-types analogue à XML generalInvoice 5.0

Éléments supprimés

Éléments à adapter

Éléments nouveau & adapté

request / body / grouping_stationary

XML 4.52

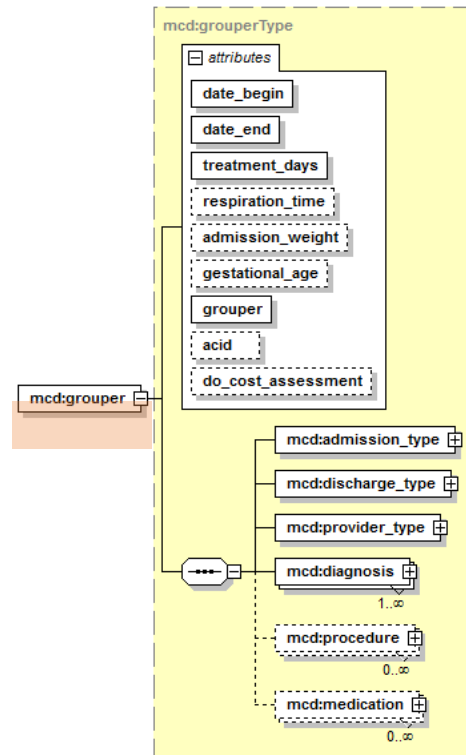

XML 5.0

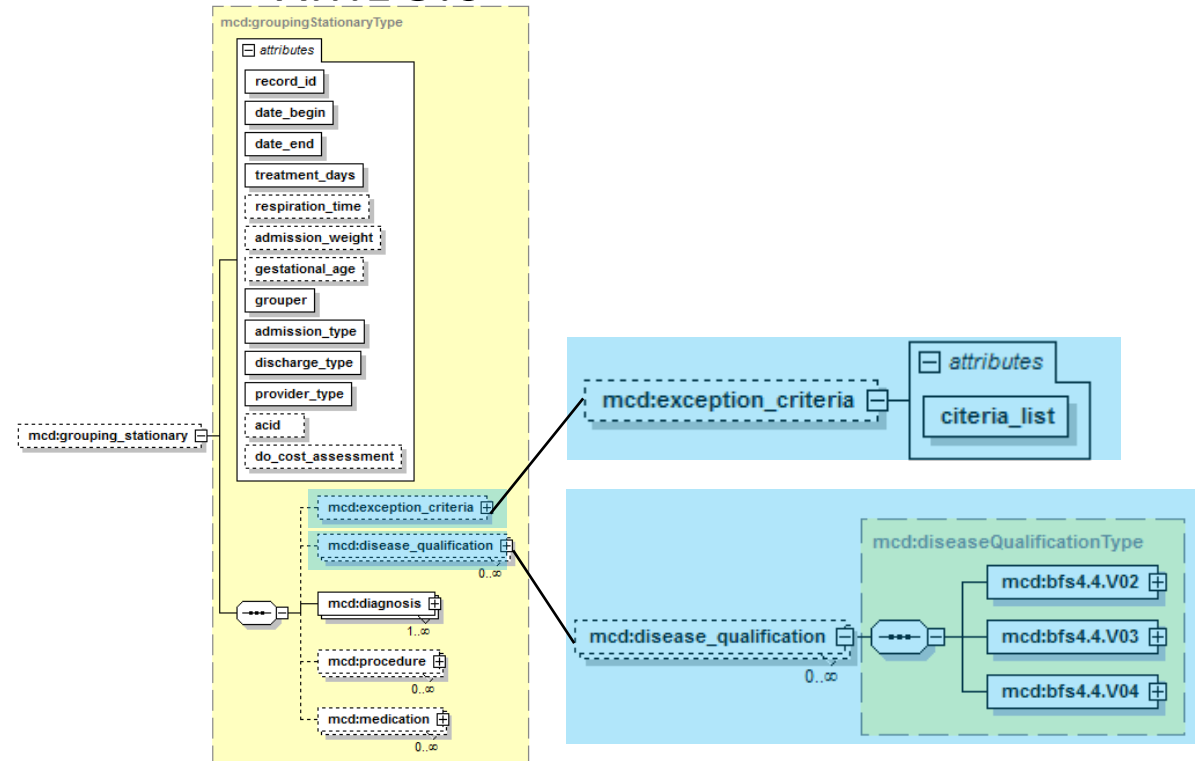

Problématique XML 4.52

Adaptations XML 5.0

Nouveau : critère ambulatoire avant stationnaire → OPAS annexe 1a

Nouveau : Statistiques hospitalières du OFS : Score de gravité, catalogue de scores et NEMS

generalMCD (Response) 5.0

response / processing

XML 4.52

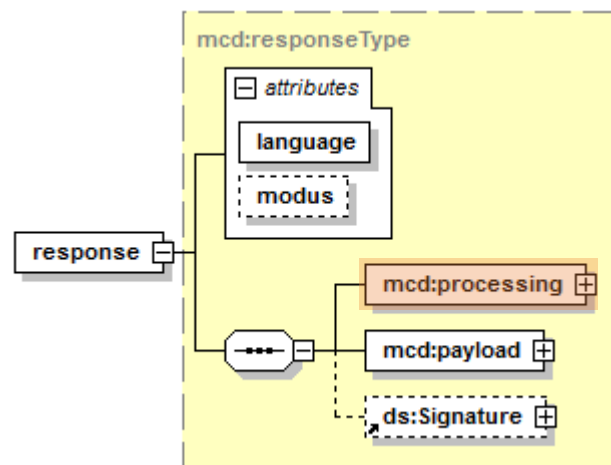

XML 5.0

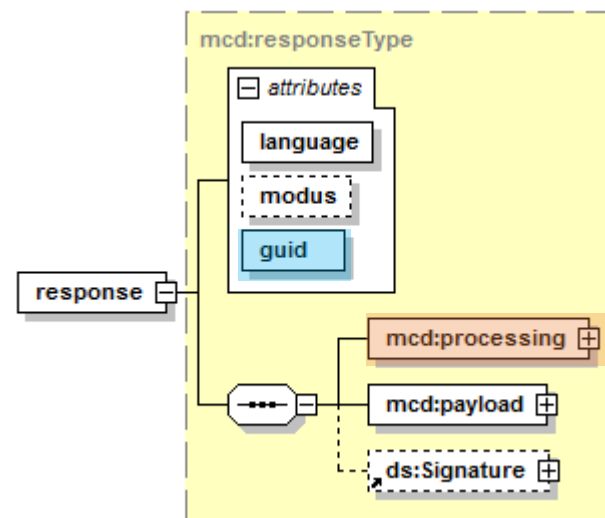

Problématique XML 4.5

Adaptations processing

Calendrier 31.12.2030

Adaptations XML 5.0

Adaptation analogique processing → generalInvoice 5.0 (via =0)

Suppression de l'ordonnancement temporel

Adaptation : Analog generalInvoice 5.0 → mcd avec guid

response / payload

XML 4.52

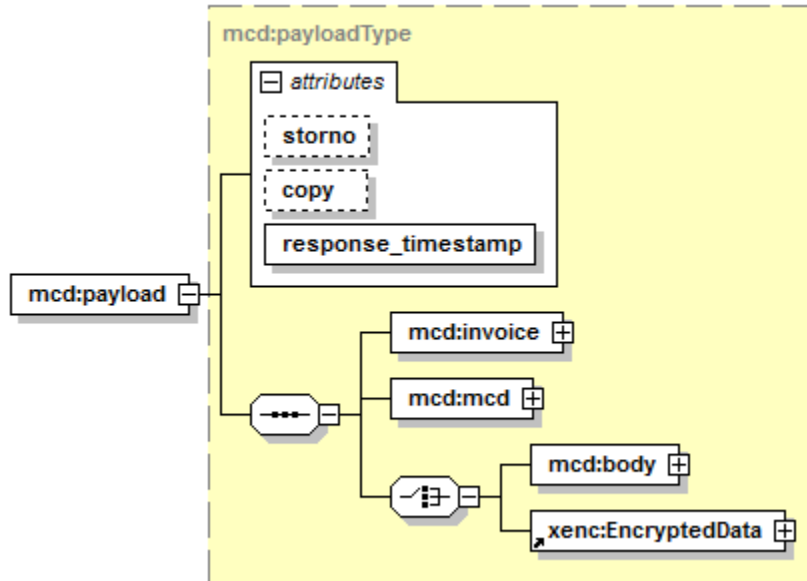

XML 5.0

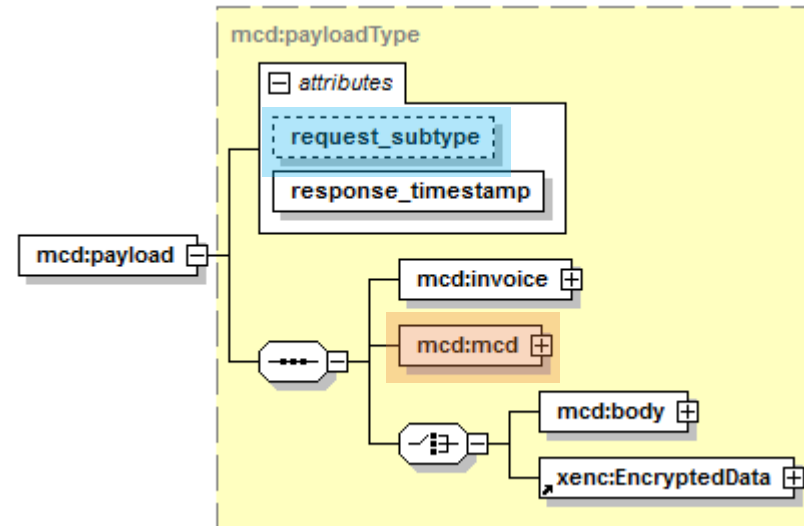

Problématique XML 4.52

Adaptations XML 5.0

Adaptation : Analog generalInvoice 5.0 → mcd avec guid

Adaptation : Analogue à generalInvoice 5.0 → Introduction de subtype

response / **body**

XML 4.52

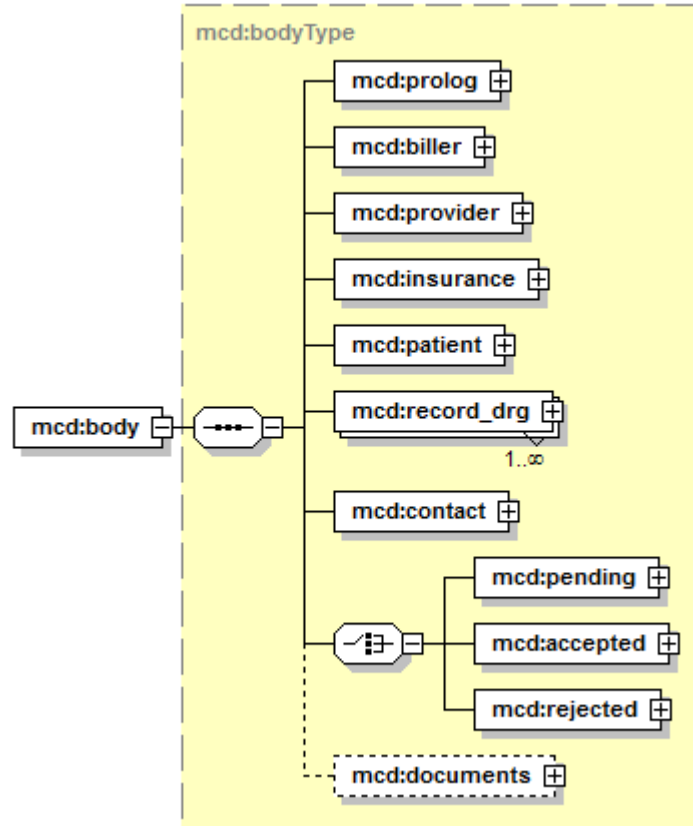

XML 5.0

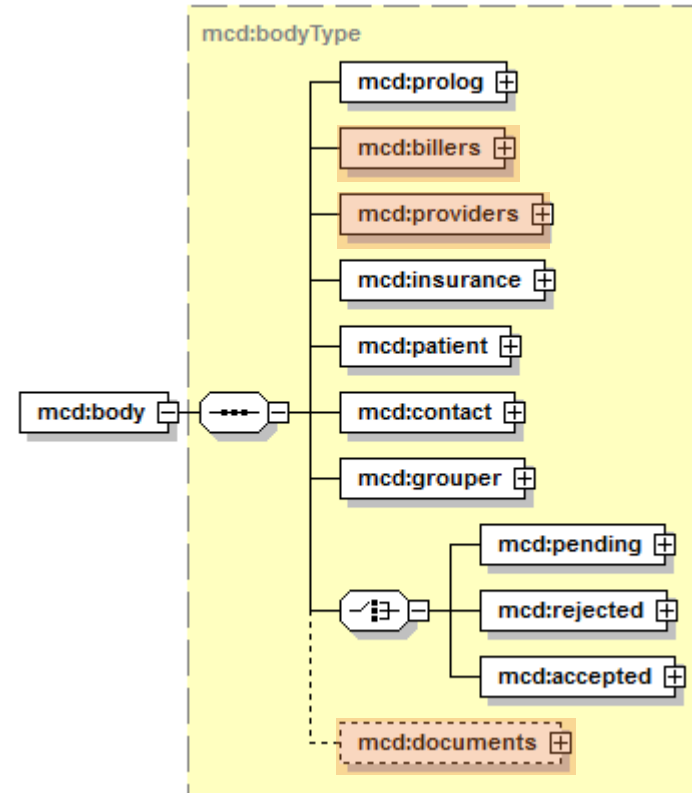

Problématique XML 4.52

Adaptations XML 5.0

Adaptation billers & provider analog XML generalInvoice 5.0

Adaptation documents-types analogue à XML generalInvoice 5.0



fachorgan@forum-datenaustausch.ch